

LAPT

2SC2922

シリコンNPNエビタキシャルプレーナ型トランジスタ (2SA1216とコンプリメンタリ)

用途：オーディオ、一般用

絶対最大定格 (Ta = 25)

記号	規格値	単位
V _{CB0}	180	V
V _{CE0}	180	V
V _{EB0}	5	V
I _C	17	A
I _B	5	A
P _C	200(T _C = 25)	W
T _J	150	
T _{stg}	- 55 ~ + 150	

電気的特性 (Ta = 25)

記号	試験条件	規格値	単位
I _{CB0}	V _{CB} = 180V	100max	μA
I _{EB0}	V _{EB} = 5V	100max	μA
V(BR)CEO	I _C = 25mA	180min	V
hFE	V _{CE} = 4V, I _C = 8V	30min	
V _{CE(sat)}	I _C = 8A, I _B = 0.8A	2.0max	V
f _T	V _{CE} = 12V, I _E = - 2A	50typ	MHz
C _{OB}	V _{CB} = 10V, f = 1MHz	250typ	pF

ランク O(30 ~ 60), Y(50 ~ 100), P(70 ~ 140), G(90 ~ 180)

外形図 MT-200

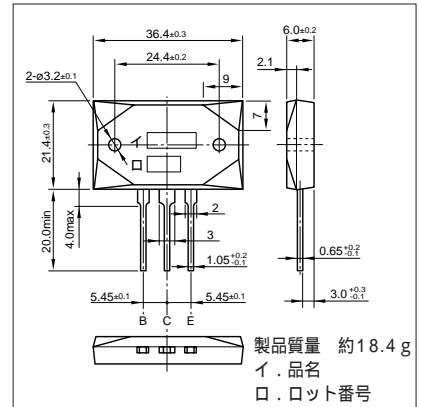

代表的スイッチング特性 (エミッタ接地)

V _{CC} (V)	R _L (Ω)	I _C (A)	V _{B2} (V)	I _{B1} (A)	I _{B2} (A)	t _{on} (μs)	t _{stg} (μs)	t _f (μs)
40	4	10	-5	1	-1	0.2typ	1.3typ	0.45typ

I_C-V_{CE}特性 (代表例)

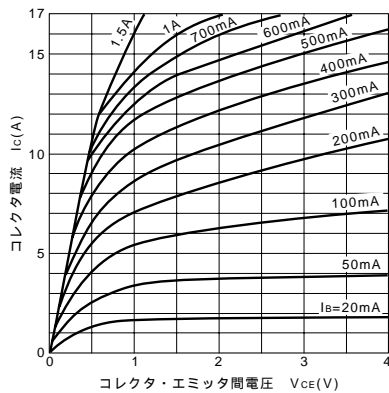

V_{CE(sat)}-I_B特性 (代表例)

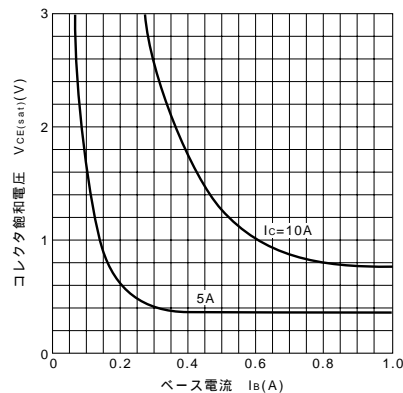

I_C-V_{BE}温度特性 (代表例)

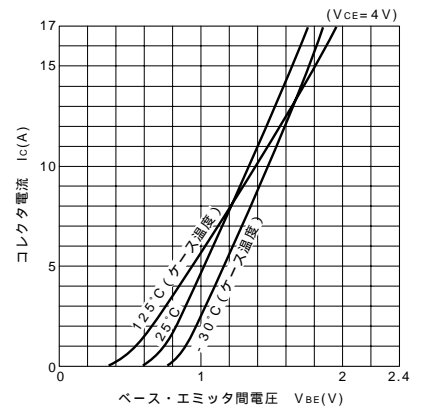

h_{FE}-I_C特性 (代表例)

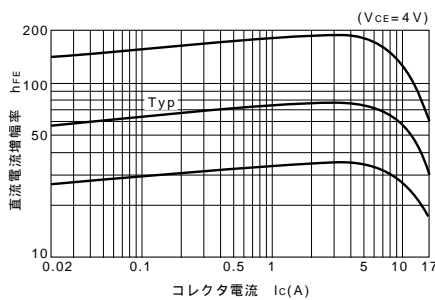

h_{FE}-I_C温度特性 (代表例)

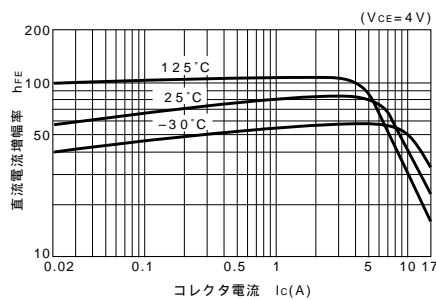

θ_{j-a}-t特性

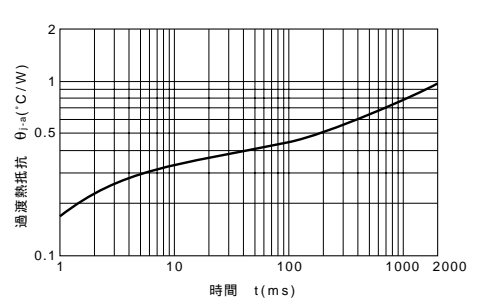

f_T-I_E特性 (代表例)

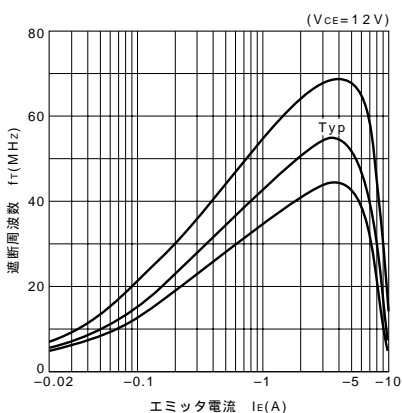

ASO曲線 (単発パルス)

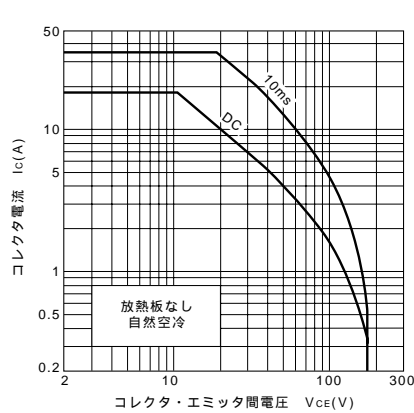

P_C-T_a定格

